

Switch Mode Power Supply

S82S (3/7.5-W Models)

CSM_S82S_DS_E_3_1

Miniature DIN Rail Mounting DC-DC Power Supplies

- 65 mm depth enables mounting onto control panels with 100 mm depth.
- Inputs: 10.2 to 27.6 VDC (DC input)
- 7.5-W models provide both ± 12 -V and ± 15 -V outputs.
- A complete lineup with 10 different models.
- UL and CSA approved.
- RoHS-compliant



⚠ Refer to *Safety Precautions for All Power Supplies*.

Model Number Structure

■ Model Number Legend

Note: Not all combinations are possible. Please refer to *List of Models* in *Ordering Information*, below.

S82S -

1 2 3

1. Input Voltage

7: 12 to 24 VDC

2. Power Ratings

3: 3 W

7: 7.5 W

3. Output Voltage

05: 5 V

12: 12 V

15: 15 V

24: 24 V

27: ± 12 V

28: ± 15 V

Ordering Information

■ List of Models

Note: For details on normal stock models, contact your nearest OMRON representative.

Power ratings	Output voltage	Output current	Model
3 W	5 V	0.6 A	S82S-7305
	12 V	0.25 A	S82S-7312
	15 V	0.2 A	S82S-7315
	24 V	0.13 A	S82S-7324
7.5 W	5 V	1.5 A	S82S-7705
	12 V	0.6 A	S82S-7712
	15 V	0.5 A	S82S-7715
	24 V	0.3 A	S82S-7724
	± 12 V	0.3 A (+12 V)/0.2 A (-12 V)	S82S-7727
	± 15 V	0.2 A (+15V)/0.2A (-15 V)	S82S-7728

Specifications

■ Ratings/Characteristics

Item			DC input		
			3 W	Single output 7.5 W	Dual Output 7.5 W
Efficiency (typical)			60% min.	66% min.	64% min.
Input	Voltage	AC	No		
		DC	10.2 to 27.6 VDC		
	Current (See note 1.)	0.6 A max.	1.2 A max.		
Output (See note 2.)	Voltage adjustment range		±5% (See note 3.)		None (See note 4.)
	Ripple (See note 1.)		2% (p-p) max.		
	Input variation influence		0.5% max.		
	Load variation influence		1.5% max.	+V: 1.5% max. -V: 3% max.	
	Temperature variation influence		0.05%/°C max.		
Additional function	Overload protection (See note 5.)		105% min., voltage drop, automatic reset		
Other	Ambient operating temperature		Refer to the derating curve in <i>Engineering Data</i>		
	Storage temperature		-25 to 65°C		
	Ambient operating humidity		25% to 85% (storage humidity: 20% to 90%)		
	Dielectric strength		1.5 kVAC for 1 min. (between all input terminals and all output terminals/PE terminals), current off: 10 mA		
	Insulation resistance		100 MΩ min. (between all output terminals and all input terminals/PE terminals) at 500 VDC		
	Vibration resistance		10 to 55 Hz, 0.375-mm single amplitude for 2 hours each in X, Y, and Z directions		
	Shock resistance		294 m/s ² , 3 times each in ±X, ±Y, ±Z directions		
	Output indicator		Yes (color: green)		
	Approved standards		Refer to <i>List of Certified Models</i> for details.		
	Weight		150 g max.		

Note: 1. A 100% load for rated input voltage.

2. Output characteristics are measured at the power supply output terminals.

3. If the output voltage adjuster (V.ADJ) is turned, the voltage will increase by more than 50% of the voltage adjustment range. When adjusting the output voltage, confirm the actual output voltage from the Power Supply and be sure that the load is not damaged.

4. The settings for the output voltage must be within the following range:

+V: ±1% of the rated value

-V: ±5% of the rated value

5. Refer to *Overload Protection* on page 4 for details.

Connections

Block Diagrams

Single Output

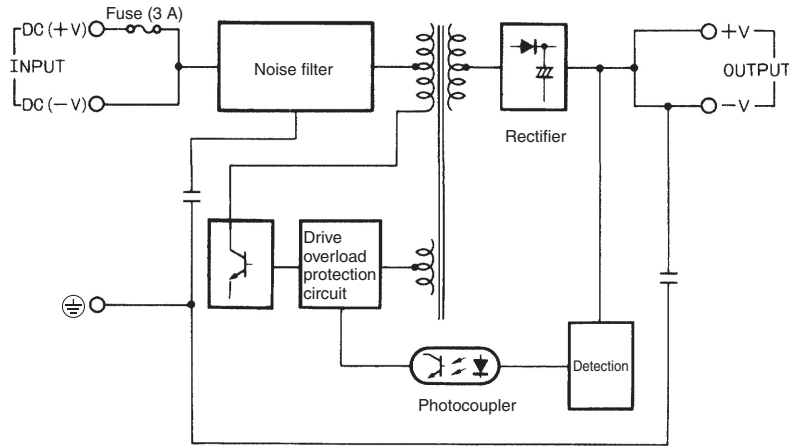

Dual Outputs

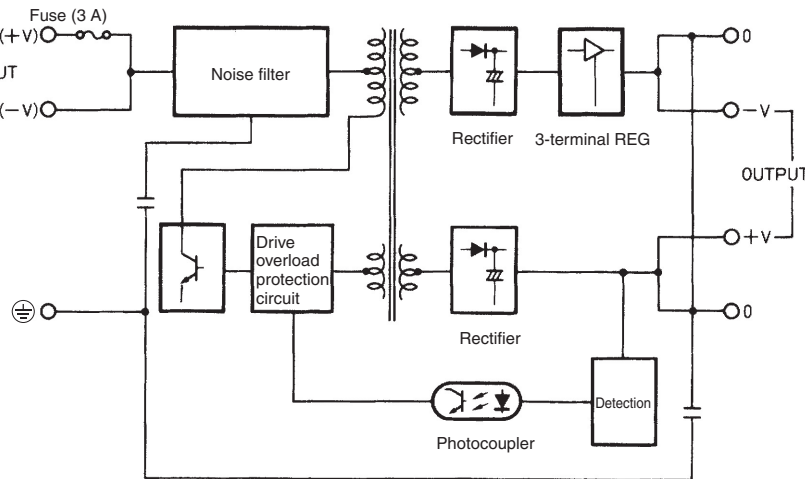

Construction and Nomenclature

Nomenclature

Terminal Arrangement

Single Output Models

Dual Output Models

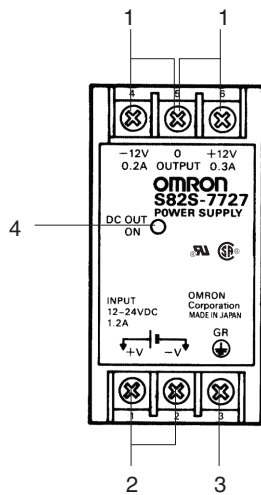
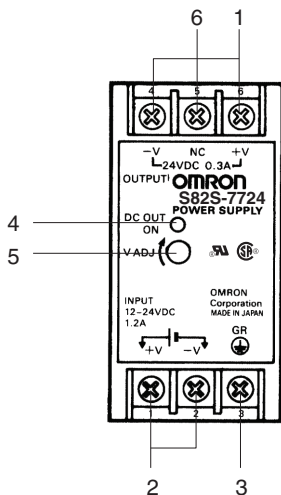

1. **DC Output Terminals:** Connect the load lines to these terminals.
2. **Input Terminals:** Connect the input lines to these terminals.
Note: The fuse is located on the (+V) side. It is NOT user replaceable.
3. **Protective earthing terminal:** Connect a ground line to this terminal.
4. **Output LED Indicator (DC OUT ON):** Lights while a DC output is ON (for the Dual Output Models, this indicator is lit when the +V DC output is ON).
5. **Output voltage adjuster (V. ADJ):** Use to adjust the output voltage.
6. **NC Terminals:** Vacant terminals.

Engineering Data

Derating Curve

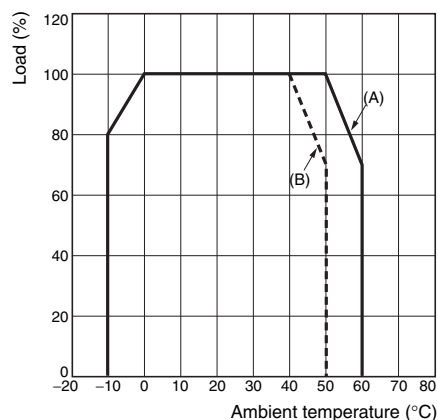

Note: The derating curve depends on the mounting direction of the Power Supply

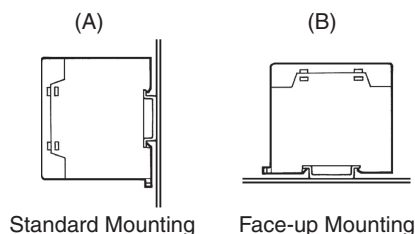

Overload Protection

The power supply is provided with an overload protection function that protects the Power Supply from possible damage by overcurrent. When the output current rises to 105% or higher of the rated current, the protection function is triggered, automatically decreasing the output voltage. When the output current falls within the rated range, the overload protection function is automatically cleared.

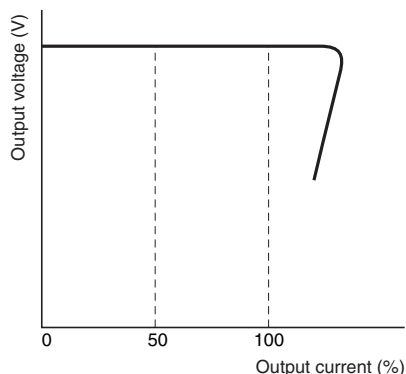

The values shown in the above diagram are for reference only.

Note: Internal parts may occasionally deteriorate or be damaged if a short-circuit or other overcurrent state continues during operation. Eliminate the overcurrent state as soon as possible.

Dual Output Models

The total output power for the +V output and -V output is detected for the protection operation (i.e., total overcurrent protection), but this condition varies depending on -V output status. -V output has an independent short-circuit protection feature.

Inrush Current, Startup Time, Hold Time

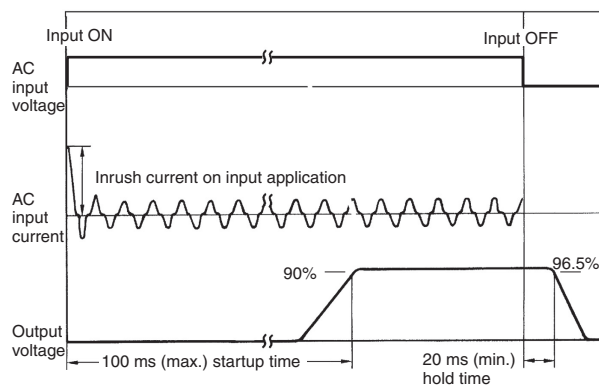

Dimensions

Note: All units are in millimeters unless otherwise indicated.

S82S-73□□ (3W)
S82S-77□□ (7.5W)

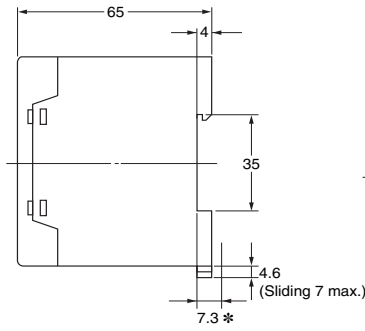
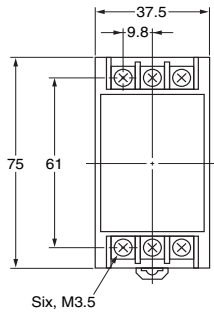
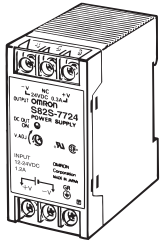

Mounting Holes

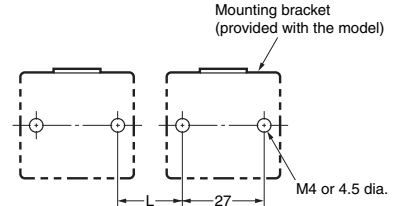

Note: If more than one Power Supply is installed in a row, keep a distance of 20 mm min. (L = 20 mm min.) between each adjacent Power Supply.

* A distance of 7.3 mm is required between the model and the mounting surface when the mounting bracket provided with the model is used.

Accessories

Note: All units are in millimeters unless otherwise indicated.

Mounting Bracket

Used when not mounting the Power Supply directly on the DIN Rail.

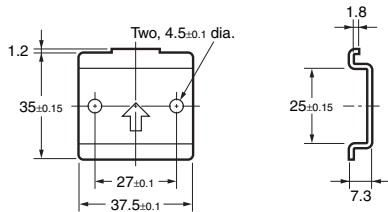

DIN Rail (Order Separately)

Mounting Rail (Material: Aluminum)

PFP-100N
PFP-50N

PFP-100N2

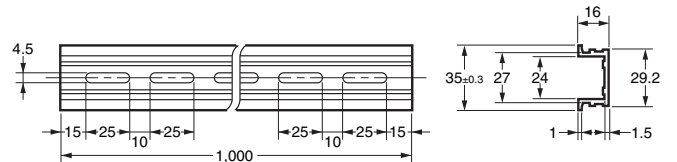
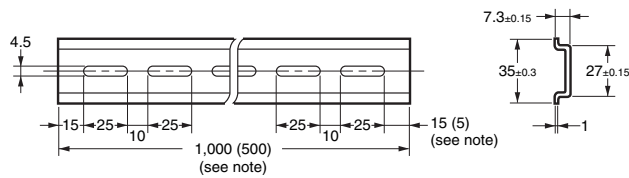
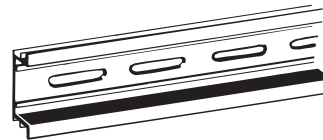
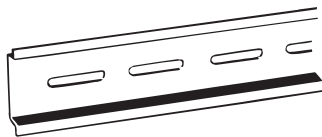

Note: The values shown in parentheses are for the PFP-50N.

Safety Precautions

CAUTION

Minor electric shock, fire, or Product failure may occasionally occur. Do not disassemble, modify, or repair the Product or touch the interior of the Product.



Minor burns may occasionally occur. Do not touch the Product while power is being supplied or immediately after power is turned OFF.



Fire may occasionally occur. Tighten terminal screws to the specified torque of 0.74 N·m (M3.5).



Minor injury due to electric shock may occasionally occur. Do not touch the terminals while power is being supplied.



Minor electric shock, fire, or Product failure may occasionally occur. Do not allow any pieces of metal or conductors or any clippings or cuttings resulting from installation work to enter the Product.



Mounting

To improve and maintain the reliability of the power supply over a long period of time, adequate consideration must be given to heat radiation.

The power supply is designed to radiate heat by means of natural air flow. Therefore, mount the power supply so that air flow takes place around the power supply.

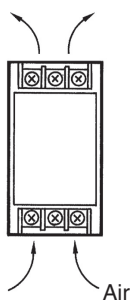

When mounting two or more power supplies side-by-side, allow at least 10 mm spacing between them, as shown in the following diagram.

Forced air-cooling is recommended.

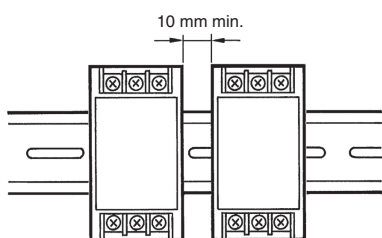

Wiring

Do not apply more than 75-N force to the terminal block when tightening it.

DIN Rail Mounting

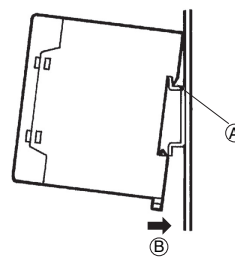

When mounting to a DIN Rail, lower the S82S onto the Rail until the Rail stopper clicks into space, hook section A over the edge of the Rail, and push in the direction of B.

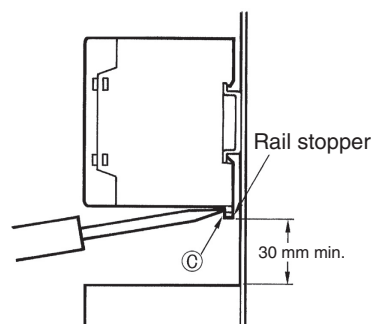

To remove the S82S from the DIN Rail, insert a screwdriver into section C and pull the S82S away from the Rail.

Serial or Parallel Operation

No serial or parallel operation is available.

The positive and negative output terminals of a Dual Output Model cannot be connected in series to operate.

Incorrect

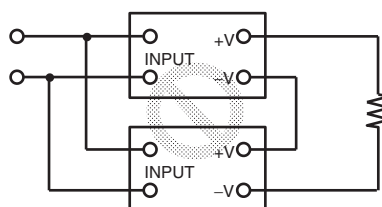

Incorrect

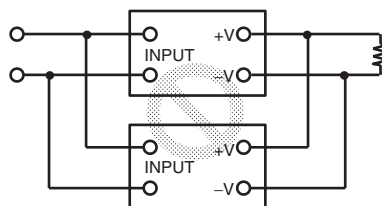

Minimum Output Current

(S82S-7727 and S82S-7728)

The minimum output current of the S82S-7727 and S82S-7728 is restricted by the output voltage and control method.

Note: All the outputs of the S82S-7727 and S82S-7728 are controlled by the +V output. If the +V output current falls to 10% or less of the rated output, the -V output voltage may drop.

ALL DIMENSIONS SHOWN ARE IN MILLIMETERS.

To convert millimeters into inches, multiply by 0.03937. To convert grams into ounces, multiply by 0.03527.

In the interest of product improvement, specifications are subject to change without notice.

Terms and Conditions Agreement

Read and understand this catalog.

Please read and understand this catalog before purchasing the products. Please consult your OMRON representative if you have any questions or comments.

Warranties.

(a) Exclusive Warranty. Omron's exclusive warranty is that the Products will be free from defects in materials and workmanship for a period of twelve months from the date of sale by Omron (or such other period expressed in writing by Omron). Omron disclaims all other warranties, express or implied.

(b) Limitations. OMRON MAKES NO WARRANTY OR REPRESENTATION, EXPRESS OR IMPLIED, ABOUT NON-INFRINGEMENT, MERCHANTABILITY OR FITNESS FOR A PARTICULAR PURPOSE OF THE PRODUCTS. BUYER ACKNOWLEDGES THAT IT ALONE HAS DETERMINED THAT THE PRODUCTS WILL SUITABLY MEET THE REQUIREMENTS OF THEIR INTENDED USE.

Omron further disclaims all warranties and responsibility of any type for claims or expenses based on infringement by the Products or otherwise of any intellectual property right. (c) Buyer Remedy. Omron's sole obligation hereunder shall be, at Omron's election, to (i) replace (in the form originally shipped with Buyer responsible for labor charges for removal or replacement thereof) the non-complying Product, (ii) repair the non-complying Product, or (iii) repay or credit Buyer an amount equal to the purchase price of the non-complying Product; provided that in no event shall Omron be responsible for warranty, repair, indemnity or any other claims or expenses regarding the Products unless Omron's analysis confirms that the Products were properly handled, stored, installed and maintained and not subject to contamination, abuse, misuse or inappropriate modification. Return of any Products by Buyer must be approved in writing by Omron before shipment. Omron Companies shall not be liable for the suitability or unsuitability or the results from the use of Products in combination with any electrical or electronic components, circuits, system assemblies or any other materials or substances or environments. Any advice, recommendations or information given orally or in writing, are not to be construed as an amendment or addition to the above warranty.

See <http://www.omron.com/global/> or contact your Omron representative for published information.

Limitation on Liability; Etc.

OMRON COMPANIES SHALL NOT BE LIABLE FOR SPECIAL, INDIRECT, INCIDENTAL, OR CONSEQUENTIAL DAMAGES, LOSS OF PROFITS OR PRODUCTION OR COMMERCIAL LOSS IN ANY WAY CONNECTED WITH THE PRODUCTS, WHETHER SUCH CLAIM IS BASED IN CONTRACT, WARRANTY, NEGLIGENCE OR STRICT LIABILITY.

Further, in no event shall liability of Omron Companies exceed the individual price of the Product on which liability is asserted.

Suitability of Use.

Omron Companies shall not be responsible for conformity with any standards, codes or regulations which apply to the combination of the Product in the Buyer's application or use of the Product. At Buyer's request, Omron will provide applicable third party certification documents identifying ratings and limitations of use which apply to the Product. This information by itself is not sufficient for a complete determination of the suitability of the Product in combination with the end product, machine, system, or other application or use. Buyer shall be solely responsible for determining appropriateness of the particular Product with respect to Buyer's application, product or system. Buyer shall take application responsibility in all cases.

NEVER USE THE PRODUCT FOR AN APPLICATION INVOLVING SERIOUS RISK TO LIFE OR PROPERTY OR IN LARGE QUANTITIES WITHOUT ENSURING THAT THE SYSTEM AS A WHOLE HAS BEEN DESIGNED TO ADDRESS THE RISKS, AND THAT THE OMRON PRODUCT(S) IS PROPERLY RATED AND INSTALLED FOR THE INTENDED USE WITHIN THE OVERALL EQUIPMENT OR SYSTEM.

Programmable Products.

Omron Companies shall not be responsible for the user's programming of a programmable Product, or any consequence thereof.

Performance Data.

Data presented in Omron Company websites, catalogs and other materials is provided as a guide for the user in determining suitability and does not constitute a warranty. It may represent the result of Omron's test conditions, and the user must correlate it to actual application requirements. Actual performance is subject to the Omron's Warranty and Limitations of Liability.

Change in Specifications.

Product specifications and accessories may be changed at any time based on improvements and other reasons. It is our practice to change part numbers when published ratings or features are changed, or when significant construction changes are made. However, some specifications of the Product may be changed without any notice. When in doubt, special part numbers may be assigned to fix or establish key specifications for your application. Please consult with your Omron's representative at any time to confirm actual specifications of purchased Product.

Errors and Omissions.

Information presented by Omron Companies has been checked and is believed to be accurate; however, no responsibility is assumed for clerical, typographical or proofreading errors or omissions.

2015.9

In the interest of product improvement, specifications are subject to change without notice.

OMRON Corporation
Industrial Automation Company

<http://www.ia.omron.com/>

(c)Copyright OMRON Corporation 2015 All Right Reserved.